

CK62 RUGGED MOBILE COMPUTER

Configuration Guide



SCAN HANDLE



UNIVERSAL DOCKS



CK62
47-KEY
ALPHANUMERIC



CK62
38-KEY
NUMERIC

THE
FUTURE
IS
WHAT
WE
MAKE IT

Honeywell

TABLE OF CONTENTS

- 1 TABLE OF CONTENTS**
- 2 CK62 FEATURE OVERVIEW**
 - S0703 STANDARD RANGE
 - ALPHANUMERIC (47-KEY)
 - NUMERIC F-KEY (38-KEY)
 - S0803 FLEXRANGE™ XLR NEAR/ EXTRA LONG RANGE
 - ALPHANUMERIC (47-KEY)
 - NUMERIC F-KEY (38-KEY)
- 6 CK62 CONFIGURATION MAP**
 - ANDROID™
- 7 HONEYWELL EDGE SERVICES**
 - GOLD REPAIR SERVICES - 3 YEAR
 - PLATINUM REPAIR SERVICES - 3 YEAR
 - CK62 - REPAIR SERVICES COVERAGE
- 9 CK62 SOFTWARE**
 - DEVICE CLIENT PACK
- 10 CK62 SCANNING**
 - SCAN HANDLE
- 11 CK62 STRAPS**
 - OPTION 1 – HANDSTRAP
 - OPTION 2 – SCAN HANDLE STRAP
- 12 CK62 DESKTOP COMMUNICATIONS**
 - OPTION 1 – PORTABLE - USB-C
 - OPTION 2 – FIXED (CHARGE ONLY)
 - OPTION 3 – FIXED WITH UNIVERSAL CUP (CHARGE ONLY)
 - UNIVERSAL CUPS
- 14 CK62 CHARGING**
 - OPTION 1 - QUAD CHARGER
 - OPTION 2 - QUAD CHARGER WITH UNIVERSAL CUP
 - OPTION 3 - 5-BAY CHARGER WITH BATTERY CUP
 - OPTION 4 - 4-BAY BATTERY CHARGER
 - OPTION 5 - 16-BAY BATTERY CHARGER
- 17 CK62 CHARGING**
 - RACK / WALL MOUNT BRACKET
- 18 CK62 BATTERY**
 - SPARE BATTERY OPTIONS
- 19 MISCELLANEOUS**
 - OPTIONAL PARTS
 - MICRO-SD CARDS
 - AC CORDS
- 23 APPENDIX**
 - CK62 VS EDA61K CHARGERS
 - CK62 VS EDA61K BATTERY CHARGERS

CK62 FEATURE OVERVIEW

S0703 Standard Range – Alphanumeric (47-Key)

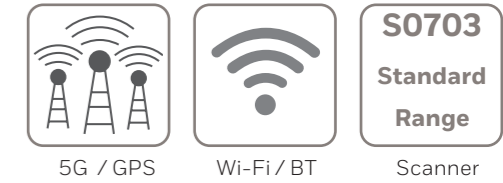

Included in the box:

- CK62 Mobile Computer
- Battery (CK67-BTSC-001)
- USB Type C cable
- Handstrap



Alphanumeric (47-Key)

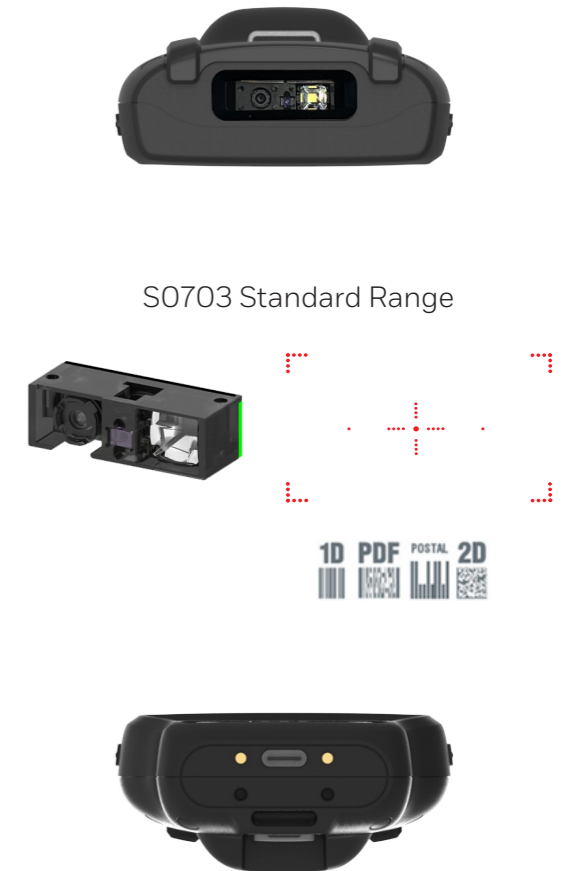

S0703 Standard Range

CK62 Alphanumeric (47-Key) - 5G WWAN – S0703 – 8GB RAM/ 128GB Flash

CK62-X10-57S1ACG

CK62, Alphanumeric (47-Key), 5G WWAN, 4.0 inch Display, Wi-Fi 6E 802.11 a/b/g/n/ac/d/h/i/r/k/v/w/mc/ax, 2x2 MU-MIMO, BT5.3 & 2nd BLE, 1x Nano SIM & 1x eSIM, USB-C, 8GB RAM/128GB Flash, S0703 Standard Range, 13MP Rear Camera, Android (GMS), Device Client Pack (DCP) Pre-Licensed (Honeywell Launcher, Enterprise Browser, BasicTE), Standard, 7,000 mAh Battery, Global

CK62 Alphanumeric (47-Key) – Wi-Fi Only – S0703 – 8GB RAM/ 128GB Flash

CK62-X00-57S1ACG

CK62, Alphanumeric (47-Key), WLAN, 4.0 inch Display, Wi-Fi 6E 802.11 a/b/g/n/ac/d/h/i/r/k/v/w/mc/ax, 2x2 MU-MIMO, BT5.3 & 2nd BLE, USB-C, 8GB RAM/128GB Flash, S0703 Standard Range, 13MP Rear Camera, Android (GMS), Device Client Pack (DCP) Pre-Licensed (Honeywell Launcher, Enterprise Browser, BasicTE), Standard, 7,000 mAh Battery, Global

CK62 Alphanumeric (47-Key) - 5G WWAN – S0703 – 4GB RAM/ 64GB Flash

CK62-X10-37S1ACG

CK62, Alphanumeric (47-Key), 5G WWAN, 4.0 inch Display, Wi-Fi 6E 802.11 a/b/g/n/ac/d/h/i/r/k/v/w/mc/ax, 2x2 MU-MIMO, BT5.3 & 2nd BLE, 1x Nano SIM & 1x eSIM, USB-C, 4GB RAM/64GB Flash, S0703 Standard Range, 13MP Rear Camera, Android (GMS), Device Client Pack (DCP) Pre-Licensed (Honeywell Launcher, Enterprise Browser, BasicTE), Standard, 7,000 mAh Battery, Global

CK62 Alphanumeric (47-Key) – Wi-Fi Only – S0703 – 4GB RAM/ 64GB Flash

CK62-X00-37S1ACG

CK62, Alphanumeric (47-Key), WLAN, 4.0 inch Display, Wi-Fi 6E 802.11 a/b/g/n/ac/d/h/i/r/k/v/w/mc/ax, 2x2 MU-MIMO, BT5.3 & 2nd BLE, USB-C, 4GB RAM/64GB Flash, S0703 Standard Range, 13MP Rear Camera, Android (GMS), Device Client Pack (DCP) Pre-Licensed (Honeywell Launcher, Enterprise Browser, BasicTE), Standard, 7,000 mAh Battery, Global

Note: Not all keypad / imager / environment combination is available in every region. Check your local Price Book to see which part numbers are available for sale.

Honeywell Repair Services

SVCK62-SG3N

CK62, Edge Service, Gold Maintenance Contract, 3 Year, New Contract

ADD SVCREPLACE-MOB3

AddOn, Edge Service, Device Replacement, Mobility, 3 Year

CK62 FEATURE OVERVIEW

S0703 Standard Range - Numeric F-Key (38-Key)

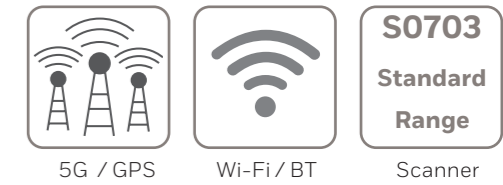

Included in the box:

- CK62 Mobile Computer
- Battery (CK67-BTSC-001)
- USB Type C cable
- Handstrap



Numeric F-Key (38-Key)



CK62 Numeric (38-Key) - 5G WWAN - S0703 - 8GB RAM/ 128GB Flash

CK62-X10-57S1BCG

CK62, Numeric F-Key (38-Key), 5G WWAN, 4.0 inch Display, Wi-Fi 6E 802.11 a/b/g/n/ac/d/h/i/r/k/v/w/mc/ax, 2x2 MU-MIMO, BT5.3 & 2nd BLE, 1x Nano SIM & 1x eSIM, USB-C, 8GB RAM/128GB Flash, S0703 Standard Range, 13MP Rear Camera, Android (GMS), Device Client Pack (DCP) Pre-Licensed (Honeywell Launcher, Enterprise Browser, BasicTE), Standard, 7,000 mAh Battery, Global

CK62 Numeric (38-Key) - Wi-Fi Only - S0703 - 8GB RAM/ 128GB Flash

CK62-X00-57S1BCG

CK62, Numeric F-Key (38-Key), WLAN, 4.0 inch Display, Wi-Fi 6E 802.11 a/b/g/n/ac/d/h/i/r/k/v/w/mc/ax, 2x2 MU-MIMO, BT5.3 & 2nd BLE, USB-C, 8GB RAM/128GB Flash, S0703 Standard Range, 13MP Rear Camera, Android (GMS), Device Client Pack (DCP) Pre-Licensed (Honeywell Launcher, Enterprise Browser, BasicTE), Standard, 7,000 mAh Battery, Global

CK62 Numeric (38-Key) - 5G WWAN - S0703 - 4GB RAM/ 64GB Flash

CK62-X10-37S1BCG

CK62, Numeric F-Key (38-Key), 5G WWAN, 4.0 inch Display, Wi-Fi 6E 802.11 a/b/g/n/ac/d/h/i/r/k/v/w/mc/ax, 2x2 MU-MIMO, BT5.3 & 2nd BLE, 1x Nano SIM & 1x eSIM, USB-C, 4GB RAM/64GB Flash, S0703 Standard Range, 13MP Rear Camera, Android (GMS), Device Client Pack (DCP) Pre-Licensed (Honeywell Launcher, Enterprise Browser, BasicTE), Standard, 7,000 mAh Battery, Global

CK62 Numeric (38-Key) - Wi-Fi Only - S0703 - 4GB RAM/ 64GB Flash

CK62-X00-37S1BCG

CK62, Numeric F-Key (38-Key), WLAN, 4.0 inch Display, Wi-Fi 6E 802.11 a/b/g/n/ac/d/h/i/r/k/v/w/mc/ax, 2x2 MU-MIMO, BT5.3 & 2nd BLE, USB-C, 4GB RAM/64GB Flash, S0703 Standard Range, 13MP Rear Camera, Android (GMS), Device Client Pack (DCP) Pre-Licensed (Honeywell Launcher, Enterprise Browser, BasicTE), Standard, 7,000 mAh Battery, Global

Note: Not all keypad / imager / environment combination is available in every region. Check your local Price Book to see which part numbers are available for sale.

Honeywell Repair Services

SVCK62-SG3N

CK62, Edge Service, Gold Maintenance Contract, 3 Year, New Contract

ADD SVCREPLACE-MOB3

AddOn, Edge Service, Device Replacement, Mobility, 3 Year

CK62 FEATURE OVERVIEW

S0803 FlexRange™ XLR Near/ Extra Long Range – Alphanumeric (47-Key)

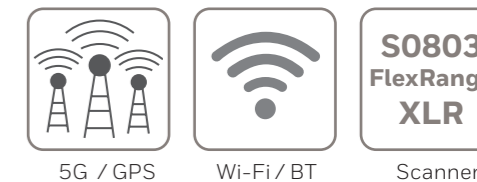

Included in the box:

- CK62 Mobile Computer
- Battery (CK67-BTSC-001)
- USB Type C cable
- Handstrap



Alphanumeric (47-Key)



S0803 FlexRange™ XLR

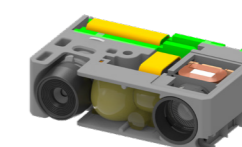

CK62 Alphanumeric (47-Key) – 5G WWAN – S0803 XLR – 8GB RAM/ 128GB Flash

CK62-X10-5ES1ACG

CK62, Alphanumeric (47-Key), 5G WWAN, 4.0 inch Display, Wi-Fi 6E 802.11 a/b/g/n/ac/d/h/i/r/k/v/w/mc/ax, 2x2 MU-MIMO, BT5.3 & 2nd BLE, 1x Nano SIM & 1x eSIM, USB-C, 8GB RAM/128GB Flash, S0803 FlexRange XLR, 13MP Rear Camera, Android (GMS), Device Client Pack (DCP) Pre-Licensed (Honeywell Launcher, Enterprise Browser, BasicTE), Standard, 7,000 mAh Battery, Global

CK62 Alphanumeric (47-Key) – Wi-Fi Only – S0803 XLR – 8GB RAM/ 128GB Flash

CK62-X00-5ES1ACG

CK62, Alphanumeric (47-Key), WLAN, 4.0 inch Display, Wi-Fi 6E 802.11 a/b/g/n/ac/d/h/i/r/k/v/w/mc/ax, 2x2 MU-MIMO, BT5.3 & 2nd BLE, USB-C, 8GB RAM/128GB Flash, S0803 FlexRange XLR, 13MP Rear Camera, Android (GMS), Device Client Pack (DCP) Pre-Licensed (Honeywell Launcher, Enterprise Browser, BasicTE), Standard, 7,000 mAh Battery, Global

CK62 Alphanumeric (47-Key) – 5G WWAN – S0803 XLR – 4GB RAM/ 64GB Flash

CK62-X10-3ES1ACG

CK62, Alphanumeric (47-Key), 5G WWAN, 4.0 inch Display, Wi-Fi 6E 802.11 a/b/g/n/ac/d/h/i/r/k/v/w/mc/ax, 2x2 MU-MIMO, BT5.3 & 2nd BLE, 1x Nano SIM & 1x eSIM, USB-C, 4GB RAM/64GB Flash, S0803 FlexRange XLR, 13MP Rear Camera, Android (GMS), Device Client Pack (DCP) Pre-Licensed (Honeywell Launcher, Enterprise Browser, BasicTE), Standard, 7,000 mAh Battery, Global

CK62 Alphanumeric (47-Key) – Wi-Fi Only – S0803 XLR – 4GB RAM/ 64GB Flash

CK62-X00-3ES1ACG

CK62, Alphanumeric (47-Key), WLAN, 4.0 inch Display, Wi-Fi 6E 802.11 a/b/g/n/ac/d/h/i/r/k/v/w/mc/ax, 2x2 MU-MIMO, BT5.3 & 2nd BLE, USB-C, 4GB RAM/64GB Flash, S0803 FlexRange XLR, 13MP Rear Camera, Android (GMS), Device Client Pack (DCP) Pre-Licensed (Honeywell Launcher, Enterprise Browser, BasicTE), Standard, 7,000 mAh Battery, Global

Note: Not all keypad / imager / environment combination is available in every region. Check your local Price Book to see which part numbers are available for sale.

Honeywell Repair Services

SVCK62-SG3N

CK62, Edge Service, Gold Maintenance Contract, 3 Year, New Contract

ADD SVCREPLACE-MOB3

AddOn, Edge Service, Device Replacement, Mobility, 3 Year

CK62 FEATURE OVERVIEW

S0803 FlexRange™ XLR Near/ Extra Long Range – Numeric F-Key (38-Key)

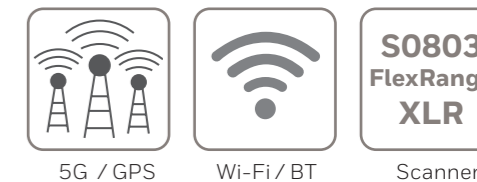

Included in the box:

- CK62 Mobile Computer
- Battery (CK67-BTSC-001)
- USB Type C cable
- Handstrap



Numeric F-Key (38-Key)



S0803 FlexRange™ XLR



CK62 Numeric (38-Key) - 5G WWAN - S0803 XLR - 8GB RAM/ 128GB Flash

CK62-X10-5ES1BCG

CK62, Numeric F-Key (38-Key), 5G WWAN, 4.0 inch Display, Wi-Fi 6E 802.11 a/b/g/n/ac/d/h/i/r/k/v/w/mc/ax, 2x2 MU-MIMO, BT5.3 & 2nd BLE, 1x Nano SIM & 1x eSIM, USB-C, 8GB RAM/128GB Flash, S0803 FlexRange XLR, 13MP Rear Camera, Android (GMS), Device Client Pack (DCP) Pre-Licensed (Honeywell Launcher, Enterprise Browser, BasicTE), Standard, 7,000 mAh Battery, Global

CK62 Numeric (38-Key) - Wi-Fi Only - S0803 XLR - 8GB RAM/ 128GB Flash

CK62-X00-5ES1BCG

CK62, Numeric F-Key (38-Key), WLAN, 4.0 inch Display, Wi-Fi 6E 802.11 a/b/g/n/ac/d/h/i/r/k/v/w/mc/ax, 2x2 MU-MIMO, BT5.3 & 2nd BLE, USB-C, 8GB RAM/128GB Flash, S0803 FlexRange XLR, 13MP Rear Camera, Android (GMS), Device Client Pack (DCP) Pre-Licensed (Honeywell Launcher, Enterprise Browser, BasicTE), Standard, 7,000 mAh Battery, Global

CK62 Numeric (38-Key) - 5G WWAN - S0803 XLR - 4GB RAM/ 64GB Flash

CK62-X10-3ES1BCG

CK62, Numeric F-Key (38-Key), 5G WWAN, 4.0 inch Display, Wi-Fi 6E 802.11 a/b/g/n/ac/d/h/i/r/k/v/w/mc/ax, 2x2 MU-MIMO, BT5.3 & 2nd BLE, 1x Nano SIM & 1x eSIM, USB-C, 4GB RAM/64GB Flash, S0803 FlexRange XLR, 13MP Rear Camera, Android (GMS), Device Client Pack (DCP) Pre-Licensed (Honeywell Launcher, Enterprise Browser, BasicTE), Standard, 7,000 mAh Battery, Global

CK62 Numeric (38-Key) - Wi-Fi Only - S0803 XLR - 4GB RAM/ 64GB Flash

CK62-X00-3ES1BCG

CK62, Numeric F-Key (38-Key), WLAN, 4.0 inch Display, Wi-Fi 6E 802.11 a/b/g/n/ac/d/h/i/r/k/v/w/mc/ax, 2x2 MU-MIMO, BT5.3 & 2nd BLE, USB-C, 4GB RAM/64GB Flash, S0803 FlexRange XLR, 13MP Rear Camera, Android (GMS), Device Client Pack (DCP) Pre-Licensed (Honeywell Launcher, Enterprise Browser, BasicTE), Standard, 7,000 mAh Battery, Global

Note: Not all keypad / imager / environment combination is available in every region. Check your local Price Book to see which part numbers are available for sale.

Honeywell Repair Services

SVCK62-SG3N



CK62, Edge Service, Gold Maintenance Contract, 3 Year, New Contract

ADD SVCREPLACE-MOB3

AddOn, Edge Service, Device Replacement, Mobility, 3 Year

CK62 CONFIGURATION MAP

Android™

CK62-											DESCRIPTION	NOTES
BLUETOOTH/ WIFI	WWAN	NFC	MEMORY	IMAGER	BATTERY	OPERATING SYSTEM	KEYBOARD	DEPLOYMENT	DOMAIN			
X											Wi-Fi 6E 802.11 a/b/g/n/ac/mc/ax, 2x2 MU-MIMO + Bluetooth 5.3	IEEE 802.11 a/b/g/n/ac/d/h/i/r/k/v/w/mc/ax, 2x2 MU-MIMO ; Wi-Fi certified Bluetooth V5.3 + EDR Class 1
	0										No WWAN	
	1										5G, LTE (4G) GPS, UMTS/HSPA+ (3G) GSM/GPRS/EDGE	WWAN RADIO - 1 x eSIM & 1 x Nano SIM Slot 5G NR SA: N1,N2,N3,N5, N7,N8,N20,N25,N26,N28,N38,N40,N41,N66,N77,N78 5G NR NSA: N40,N41,N77,N78 TDD-LTE: B34,38,B39,B40,B41,B42,B43 FDD-LTE: B1,B2,B3,B4,B5,B7,B8,B12,B13,B17,B19,B20,B25,B26,B28,B66
		0									No Near Field Communications (NFC)	
		--										
			3								4GB RAM, 64GB Flash Memory	Qualcomm QCS4490/ QCM4490 octa-core 2.4GHz
			5								8GB RAM, 128GB Flash Memory	Qualcomm QCS4490/ QCM4490 octa-core 2.4GHz
				7							1D/2D Imager (S0703SR) – Standard Range	
				E							1D/2D Imager (S0803) – FlexRange™ XLR	
					S						Standard Battery 7,000mAh	
						1					Android (GMS)	Google Mobile Services (GMS) certified – Play Store
						2					Android (Non-GMS)	
							A				Alphanumeric (47-Key)	
							B				Numeric F-Key (38-Key)	
								C			13MP Rear Camera	
									C		China (WWAN or Wi-Fi)	China
										G	Global (WWAN or Wi-Fi)	Argentina, Australia, Brazil, Canada, Chile, Colombia, Egypt, Europe, Indonesia, Malaysia, Mexico, Morocco, New Zealand, Peru, Philippines, Saudi Arabia, Singapore, South Africa, South Korea, Thailand, Tunisia, Turkey, UAE, United Kingdom, United States of America
										N	India (WWAN or Wi-Fi)	India - No WLAN 6GHz support
										S	Global (WWAN or Wi-Fi)	1 x Nano SIM, No eSIM
										V	Vietnam (WWAN or Wi-Fi)	Vietnam - 2G/3G/4G support



HONEYWELL EDGE SERVICES

CK62 – Repair Services

Honeywell Edge Services give you the confidence of having leading-class technologies combined with service and support plans that are designed to keep you operational for longer.

For a full description of maintenance services, including terms and conditions, please see <https://sps.honeywell.com/us/en/services/productivity/support-services/maintenance-services>

Gold Repair Services – 3 Year

The Edge Services Gold Support contract allows flexibility for you to select the right coverage for your organization, including 5-Day Depot Repairs and:

Service Overview

- Repair or replacement (at Honeywell discretion) for damaged components, wear and tear, accidental damage
- Flexibility to add any Add-On Service
- Android Service - includes Android OS Upgrades, Maintenance Releases and Security Patches

PART NUMBER	DESCRIPTION
SVCK62-SG3N	CK62, Edge Service, GOLD Maintenance Contract, 5 Day Turnaround, 3 Year , New Contract

Add-On Accessory Replacement Service

Provides replacement chargers, docks, charging cables, or scan handles should they be damaged or stop working.

ADD SVCACC-MOB3	AddOn, Edge Service, Accessory Service , Mobility, 3 Year . Service covers docks, charger cradles, scan handles
------------------------	--

Add-On Battery Replacement Service

Provides replacement batteries every 18 months after purchase.

ADD SVCBATTERY-MOB3	AddOn, Edge Service, Battery Service, Mobility, 3 Year , 1 Replacement Battery over life of contract
----------------------------	---

Add-On Device Replacement Service

Replacement devices should a device be damaged beyond repair.

ADD SVCREPLACE-MOB3	AddOn, Edge Service, Device Replacement, Mobility, 3 Year
----------------------------	--

Add-On Image Management Service

Ensures that when a device returns from being repaired, it has all the proper applications loaded back on the device.

ADD SVCIMAGEMGMT-MOB3	AddOn, Edge Service, Image Service, Mobility, 3 Year
------------------------------	---

Add-On Spare Management Service

Manages every aspect of your spare pool.

ADD SVCSPAREMGMT-MOB3	AddOn, Edge Service, Advanced Exchange, Mobility, 3 Year . Customer owned spare pool, Minimum Purchase required, contact your local Honeywell Service Representative for more information.
------------------------------	---

Add-On 2-Day Turnaround Depot Upgrade

Upgrade your Gold Maintenance Contract from 5-Day to 2-Day turnaround at the repair depot.

ADD SVC2DAYDEPOT-MOB3	AddOn, Edge Service, 2-Day Depot Upgrade, 3-Year Agreement, Requires purchase of a 3 Year Gold Maintenance Contract.
------------------------------	---

Platinum Repair Services – 3 Year

The Edge Services Platinum Support contract offers 2-Day Depot Repairs or Spare Pool Management with 3 year contract that includes:

Service Overview

- Repair or replacement (at Honeywell discretion) for damaged components, wear and tear, accidental damage
- SVCREPLACE-MOB3 - Replacement devices should a device be damaged beyond repair
- SVCACC-MOB3 - Accessory replacement service
- SVCBATTERY-MOB3 - Battery replacement service
- SVCSPAREMGMT-MOB3 - Spare pool management (optional, minimum quantity required)
- Telephone-based technical support
- Android Service - includes Android OS Upgrades, Maintenance Releases and Security Patches

PART NUMBER	DESCRIPTION
SVCK62-SP3N	CK62, Edge Service, PLATINUM, 2 Day Turnaround, 3 Year , New Contract



HONEYWELL REPAIR SERVICES

CK62 – Repair Services Coverage

For Best-In-Class Service



CK62

Warranty Cover Against Product Defect

BASIC Service

Gold Coverage:

- Accidental Damage
- Wear & Tear
- Android Service

Includes Replacement of:

- Handstrap
- Screen Protector



Flexible GOLD Add-Ons ordered separately

- SVCACC-MOB3 Accessories
- SVCBATTERY-MOB3 Batteries
- SVCREPLACE-MOB3 Device Replacement
- SVCIMAGEMGMT-MOB3 Image Service
- SVCSPAREMGMT-MOB3 Advanced Exchange

GOLD Service

Platinum Coverage

- Battery Replacement
- Coverage for Docks/ Chargers
- Android Service

- Accidental Damage
- Device Replacement
- Wear & Tear



Scan Handle

Battery

Dock Power Supplies

Universal Docks

(3 Year – 1 replacement battery per CK62)

PLATINUM Service

COVERAGE	PART NUMBER	DESCRIPTION
BASIC	SVCC62-EXW2	CK62, BASIC, 10-15 Day Turnaround, 2 Years (1 Year Factory Warranty + 1 Year Extended)
GOLD	SVCC62-SG3N	CK62, Edge Service, GOLD Maintenance Contract, 5 Day Turnaround, 3 Year, New Contract
ADD	SVCACC-MOB3	AddOn, Edge Service, Accessory Service, Mobility, 3 Year. Service covers docks, charger cradles, scan handles and car adapter
ADD	SVCBATTERY-MOB3	AddOn, Edge Service, Battery Service, Mobility, 3 Year, 1 Replacement Battery over life of contract
ADD	SVCREPLACE-MOB3	AddOn, Edge Service, Device Replacement, Mobility, 3 Year
ADD	SVCIMAGEMGMT-MOB3	AddOn, Edge Service, Image Service, Mobility, 3 Year
ADD	SVCSPAREMGMT-MOB3	AddOn, Edge Service, Advanced Exchange, Mobility, 3 Year. Customer owned spare pool, Minimum Purchase required.
PLATINUM	SVCC62-SP3N	CK62, Edge Service, PLATINUM, 2 Day Turnaround, 3 Year, New Contract

CK62 SOFTWARE

Device Client Pack

The CK62 Device Client Pack (DCP) includes Launcher, Enterprise Browser, BasicTE, and Mobility Web SDK, these applications have a perpetual pre-license (equivalent to DCP-001 license), which also includes 1 Year Software Maintenance.

The SmartTE Terminal Emulator is pre-loaded on the CK62, but it is NOT pre-licensed, it requires a SmartTE license to be purchased separately.

There are two licensing options that can be purchased for SmartTE:

1. Single Session License Purchase SMARTTE-001 - This allows users to connect a single telnet session to their telnet Host server.
2. Multi Session License Purchase SMARTTE-D-001 - This allows users to connect multiple telnet sessions simultaneously to their Host telnet server.

Device Client Pack



Launcher



Launcher - gives the customer total control over which apps can be run on the device.



BasicTE



BasicTE Android device Terminal Emulation is a simplified alternative for those not yet ready to upgrade to SmartTE.



Enterprise Browser



Enterprise Browser provides corporations the ability to run standard web applications from a controlled environment.

Order Separately



SmartTE Terminal Emulator



Terminal Emulator - Full featured SmartTE allows legacy green screen apps to be transformed to the look and feel of native apps. They can also utilize traditional single or multi-session StayLinked Licenses.

SmartTE is Pre-Loaded, but requires license SMARTTE-001 or SMARTTE-D-001 to be purchased separately.

Single Session License

This license allows a single telnet session to be active on the device.

PART NUMBER	DESCRIPTION
SMARTTE-001	SmartTE - Single path with 1 Year Maintenance
SMARTTE-SFT1	SmartTE - 1 Year Software Maintenance
SMARTTE-SFT2	SmartTE - 2 Year Software Maintenance
SMARTTE-SFT3	SmartTE - 3 Year Software Maintenance
SMARTTE-SFT4	SmartTE - 4 Year Software Maintenance
SMARTTE-SFT5	SmartTE - 5 Year Software Maintenance
SMARTTE-SND-SFT1	SmartTE - High availability secondary backup or development server 1yr maintenance. Not for primary server. Purchase one per device.

Multi Session License

This license allows multiple telnet sessions to be concurrently active on the device.

PART NUMBER	DESCRIPTION
SMARTTE-D-001	SmartTE - Multi Sessions with 1 Year Maintenance
SMARTTE-D-SFT1	SmartTE - 1 Year Multi Sessions Software Maintenance
SMARTTE-D-SFT2	SmartTE - 2 Year Multi Sessions Software Maintenance
SMARTTE-D-SFT3	SmartTE - 3 Year Multi Sessions Software Maintenance
SMARTTE-D-SFT4	SmartTE - 4 Year Multi Sessions Software Maintenance
SMARTTE-D-SFT5	SmartTE - 5 Year Multi Sessions Software Maintenance
SMARTTE-SND-SFT1	SmartTE - High availability secondary backup or development server 1yr maintenance. Not for primary server. Purchase one per device.

PART NUMBER	DESCRIPTION
DCP-SFT1	Device Client Pack - 1 Year Term + Maintenance (License covers Launcher, Enterprise Browser, BasicTE, and Mobility Web SDK)
DCP-SFT2	Device Client Pack - 2 Year Term + Maintenance (License covers Launcher, Enterprise Browser, BasicTE, and Mobility Web SDK)
DCP-SFT3	Device Client Pack - 3 Year Term + Maintenance (License covers Launcher, Enterprise Browser, BasicTE, and Mobility Web SDK)
DCP-SFT4	Device Client Pack - 4 Year Term + Maintenance (License covers Launcher, Enterprise Browser, BasicTE, and Mobility Web SDK)
DCP-SFT5	Device Client Pack - 5 Year Term + Maintenance (License covers Launcher, Enterprise Browser, BasicTE, and Mobility Web SDK)

CK62 SCANNING

Scan Handle

Use for Scan intensive applications.
Not compatible with Stylus.



Rear Angle Exploded View

	PART NUMBER	DESCRIPTION
1	CK62-SH	CK62 Scan Handle, field attachable scan handle

CK62 STRAPS

Option 1 – Handstrap

Not Compatible with CK62-SH Scan Handle



PART NUMBER

DESCRIPTION

1	CK62-HS-5PK	CK62 Hand Strap (5 pieces per pack)
OR	CK62-HS-5PK-MX	CK62 Hand Strap (5 pieces per pack) - Mexico Only

Option 2 – Scan Handle Strap

Compatible with CK62-SH Scan Handle



PART NUMBER

DESCRIPTION

1	EDA61K-SHS-3PK	Hand Strap for CK62/EDA61K Scan Handle (3 pieces per pack)
OR	EDA61K-SHS-3PK-MX	Hand Strap for CK62/EDA61K Scan Handle (3 pieces per pack) - Mexico Only

CK62 DESKTOP COMMUNICATIONS

Option 1 – Portable – USB-C

USB Communication to PC/ Mac OR Snap-On Charging.



PART NUMBER	DESCRIPTION
1	CBL-500-120-S00-06 USB type A to type C, 1.2 m (3.9 ft)
2	50136024-001 KIT,5V/2A PS,5 PLUGS PACKED, ROW Includes US,UK,AU,EU,IN adapters

Option 2 – Fixed (Charge Only)

CK62/ EDA61K terminal charger & single battery charger (No communication ports)

Supports Batteries: CK67-BTSC-001 - Smart Battery Pack, CK67/CK62 (7000mAh)
50149348-001 - Battery Pack, EDA61K (7000mAh)



PART NUMBER	DESCRIPTION
1	EDA61K-HB-0 Home Base for recharging computer and battery, without I/O connector, without power cord
2	** IEC C13 AC Power Cord – See Page 22 for Country Specific Power Cords
3	CK67-BTSC-001 Smart Battery Pack, CK67/CK62 (7000mAh)

CK62 DESKTOP COMMUNICATIONS

Option 3 – Fixed with Universal Cup (Charge Only)

USB & Single Battery Charger.

Supports Batteries:

CK67-BTSC-001 - Smart Battery Pack, CK67/CK62 (7000mAh)

50149348-001 - Battery Pack, EDA61K (7000mAh)



PART NUMBER	DESCRIPTION
1	CK62-HB-UVN-0 HomeBase - Kit includes (CK62-UCP-N), Dock & Power Supply, No Power Cord
2	321-576-004 Cable Assembly - USB Type A to Type B
3	** IEC C13 AC Power Cord – See Page 22 for Country Specific Power Cords
4	CK67-BTSC-001 Smart Battery Pack, CK67/CK62 (7000mAh)

Universal Cups

Compatible with CK62-HB-UVN-0 Home Base

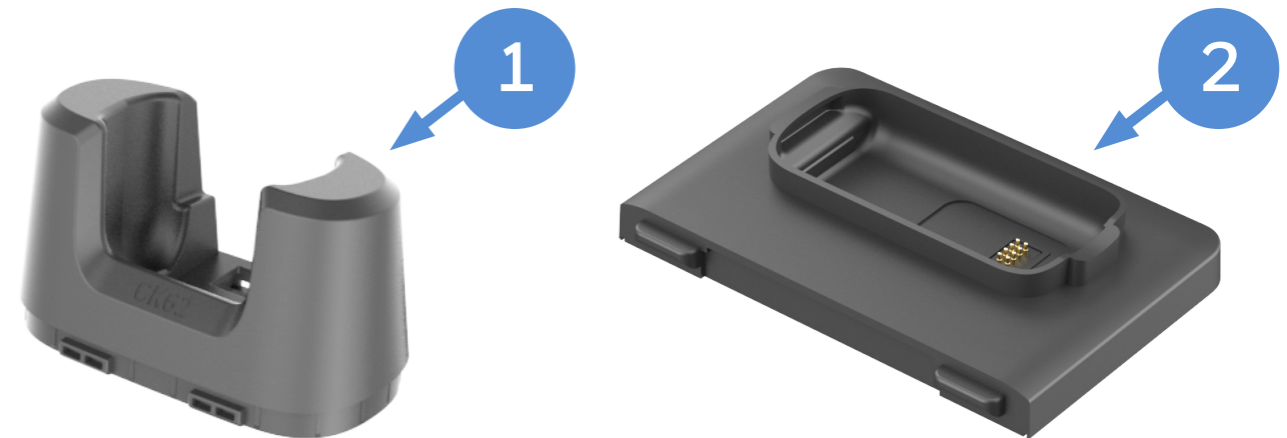

PART NUMBER	DESCRIPTION
1	CK62-UCP-N CK62 Universal Cup
2	CK6X-UCP-BATTHEB CK67/CK62 Home Base and Ethernet Base battery cup. Cannot charge a mobile computer.

CK62 CHARGING

Option 1 - Quad Charger

Supports: EDA61K and CK62.

Compatible with Scan Handle

Optional, this dock also supports:

203-641-002 FlexDock/Multidock Wall Mounting Kit

OR

CB-BK-01 4 Bay Charger Bracket, Rack / Wall Mount

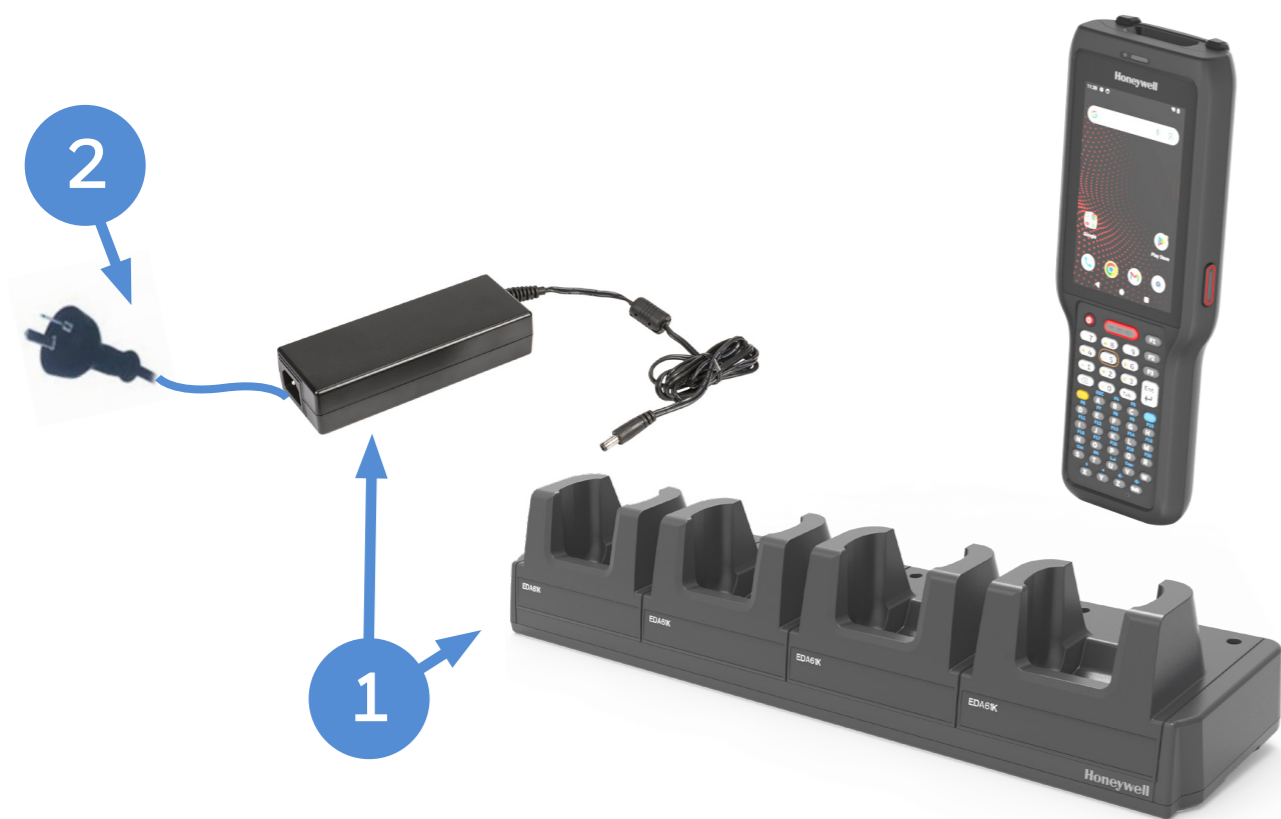

Option 2 - Quad Charger with Universal Cup

Supports: EDA61K and CK62.

Compatible with Scan Handle

Optional, this dock also supports:

203-641-002 FlexDock/Multidock Wall Mounting Kit

OR

CB-BK-01 4 Bay Charger Bracket, Rack / Wall Mount

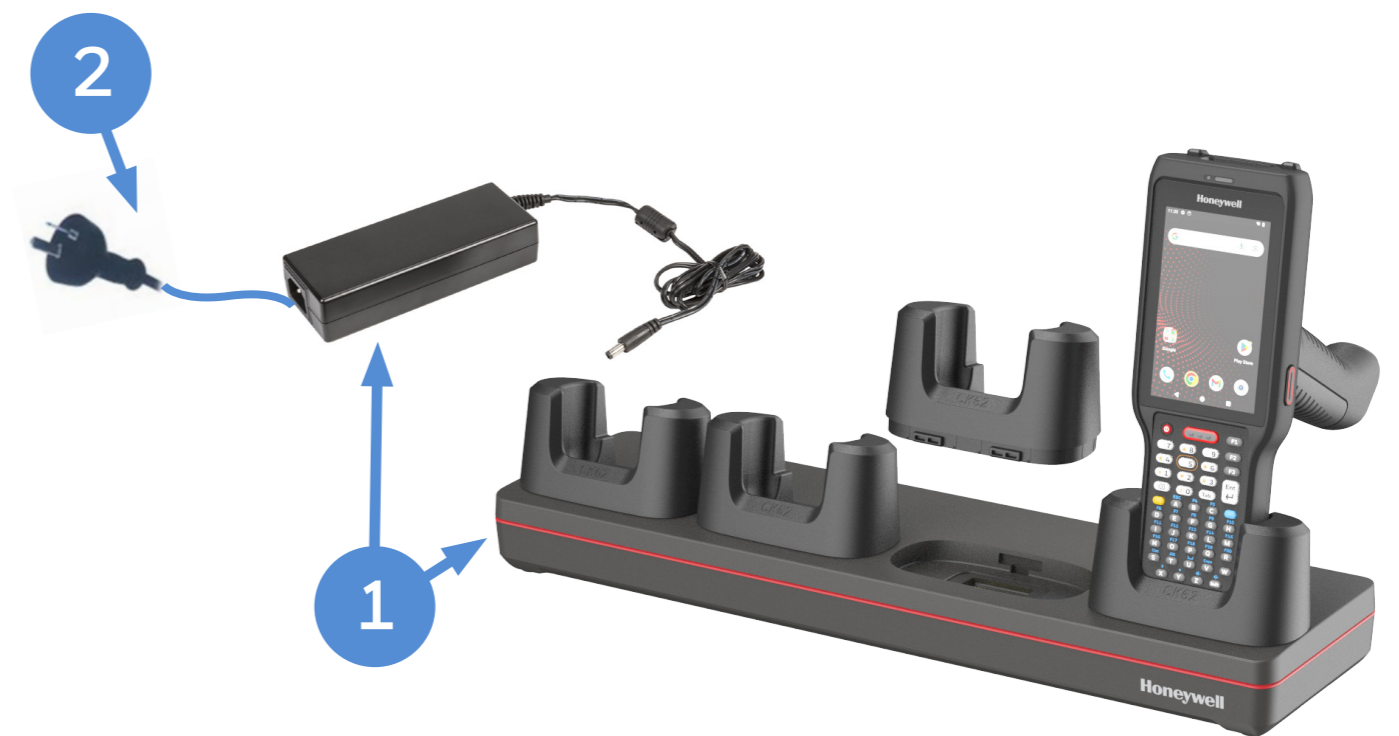

Kit Includes:
4 x CK62-UCP-N
CK62 Cup

PART NUMBER	DESCRIPTION
1 EDA61K-CB-0	CK62/EDA61K Chargebase - Kit includes Dock and Power Supply
2 **	IEC C13 AC Power Cord – See Page 22 for Country Specific Power Cords

PART NUMBER	DESCRIPTION
1 CK62-CB-UVN-0	CK62 Chargebase - Kit includes Dock and Power Supply
2 **	IEC C13 AC Power Cord – See Page 22 for Country Specific Power Cords

CK62 CHARGING

Option 3 - 5-Bay Charger with Battery Cup

Chargebase – Quad Dock Charge Only (4 terminals) and Quad Battery Charger (4 Batteries)
 Compatible with Scan Handle



Top View with Scan Handle installed

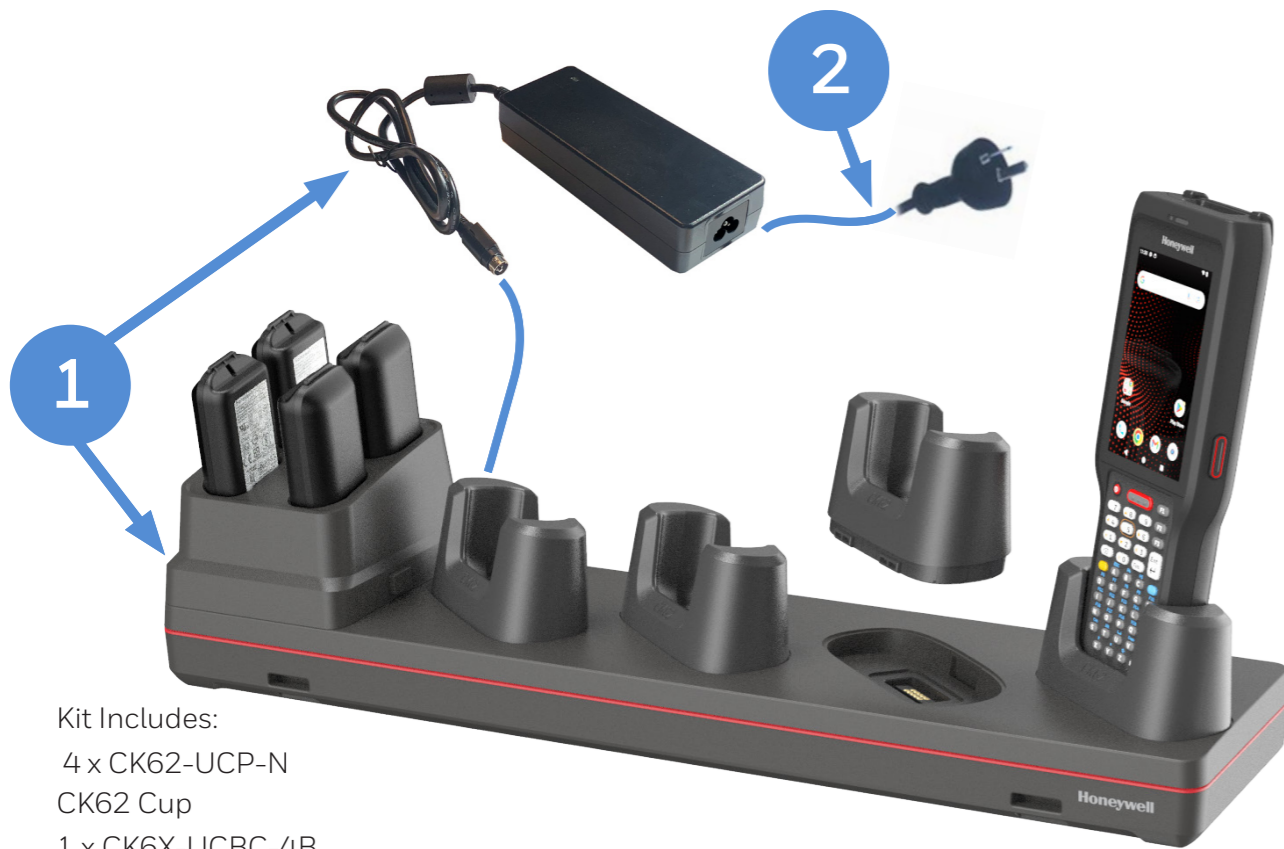

- Kit Includes:
 4 x CK62-UCP-N
 CK62 Cup
 1 x CK6X-UCBC-4B

PART NUMBER	DESCRIPTION
1 CK62-5CB-UVN-BAT-0	CK62 5 bay Universal Dock, charge up to 4 devices and 4 CK62 batteries. Kit includes 5 bay Universal Dock and Power Adaptor.
2 **	IEC C5 AC Power Cord – See Page 22 for Country Specific Power Cords

CK62 CHARGING

Option 4 - 4-Bay Battery Charger

Supports Batteries: CK67-BTSC-001 - Smart Battery Pack, CK67/CK62 (7000mAh)
50149348-001 - Battery Pack, EDA61K (7000mAh)

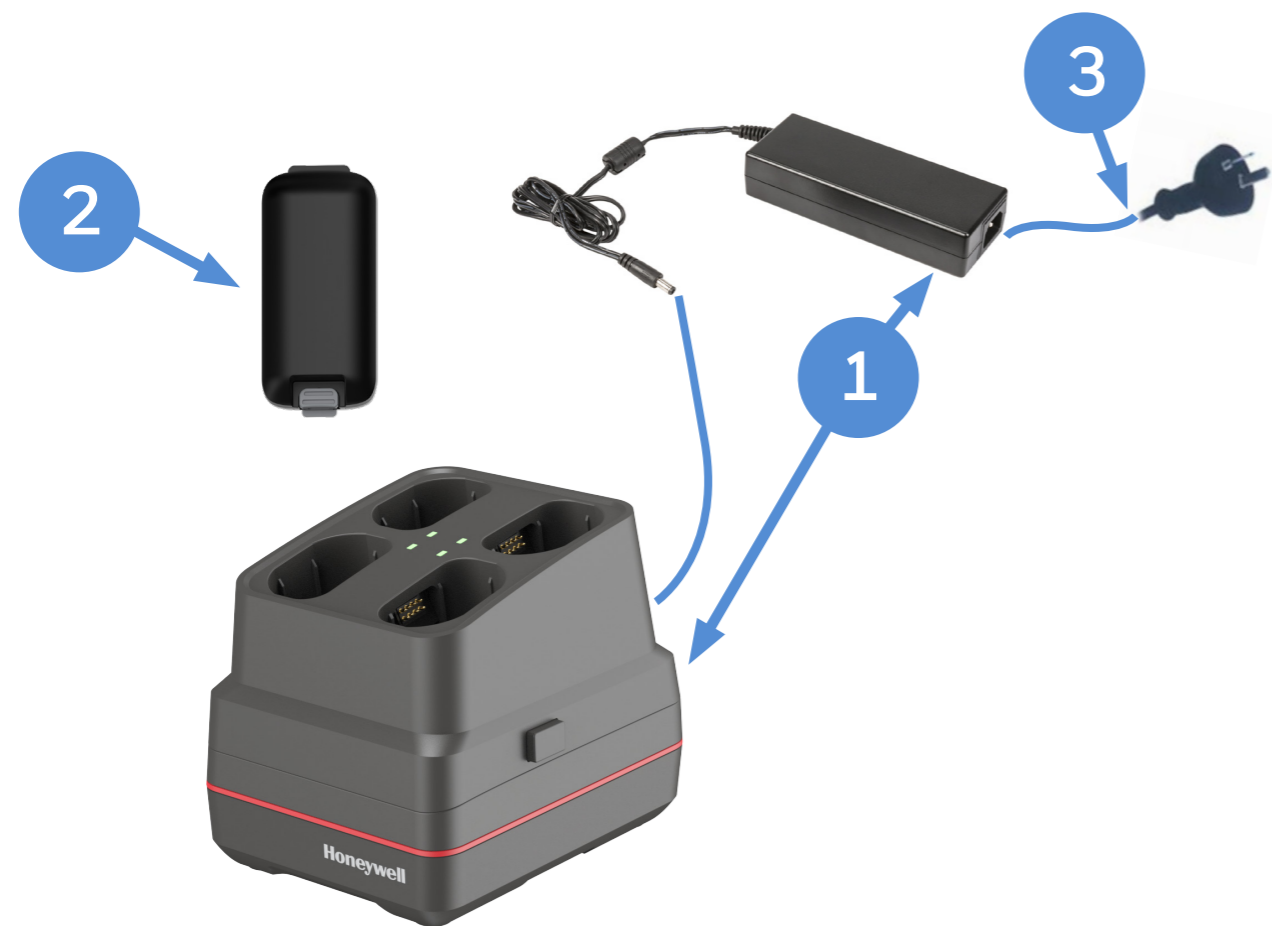

Batteries not included.

PART NUMBER	DESCRIPTION
1	CK6X-BC-4BAY-0 Quad Battery Charger - Kit includes (CK6X-UCBC-4B), Dock and Power Supply
2	CK67-BTSC-001 Battery, Standard, CK67 (7000mAh)
3	** IEC C13 AC Power Cord – See Page 22 for Country Specific Power Cords

Option 5 - 16-Bay Battery Charger

Supports Batteries: CK67-BTSC-001 - Smart Battery Pack, CK67/CK62 (7000mAh)
50149348-001 - Battery Pack, EDA61K (7000mAh)

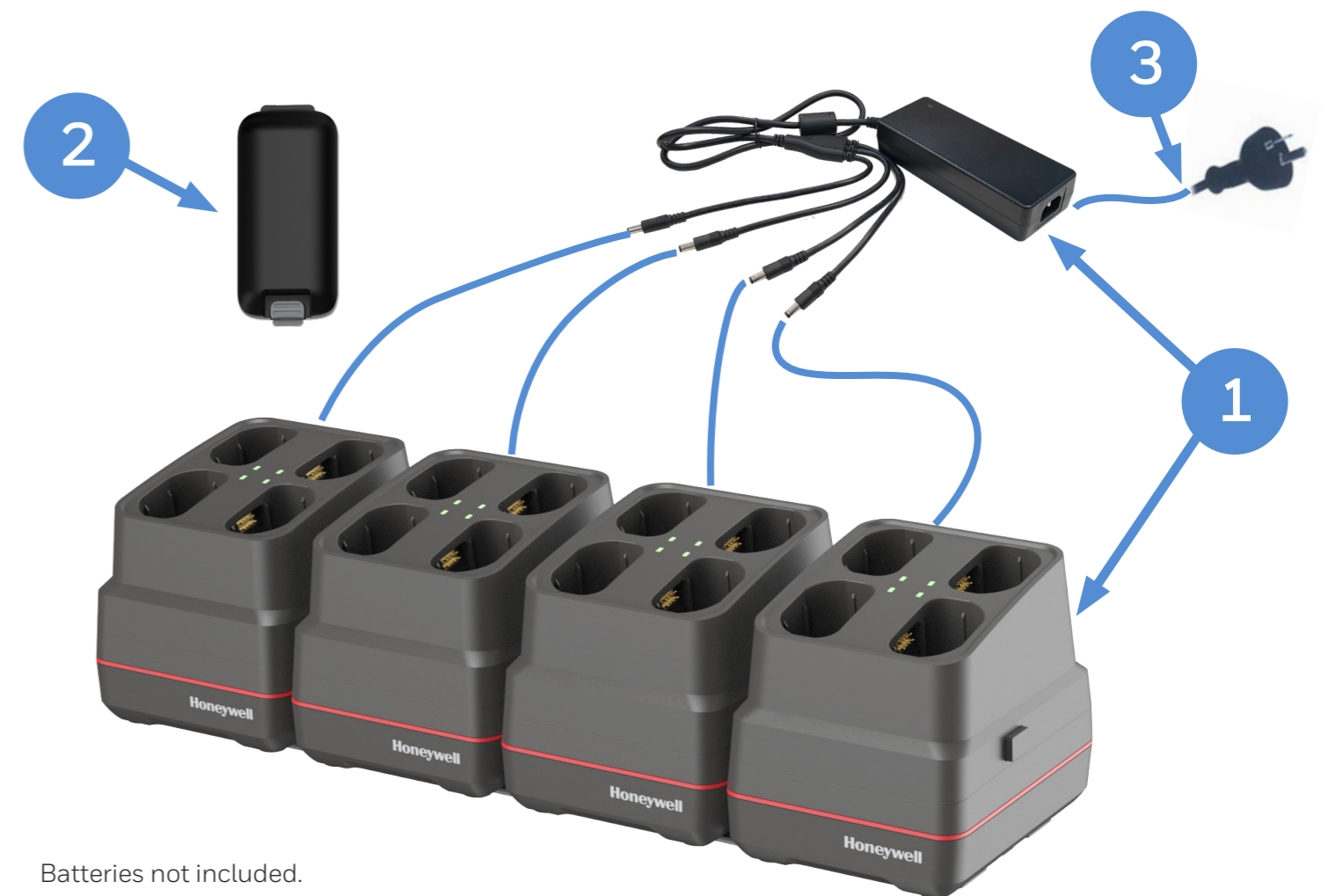

Batteries not included.

PART NUMBER	DESCRIPTION
1	CK6X-BC-16BAY-0 Quad Battery Charger - Kit includes (4 x CK6X-UCBC-4B), Dock and Power Supply
2	CK67-BTSC-001 Battery, Standard, CK67 (7000mAh)
3	** IEC C13 AC Power Cord – See Page 22 for Country Specific Power Cords

CK62 CHARGING

Rack / Wall Mount Bracket

The Rack/Wall Mount Bracket has been optimized to work on a standard 19-inch (48cm) rack, as well as mounting directly onto a wall. Compatible with all 4-bay chargers.

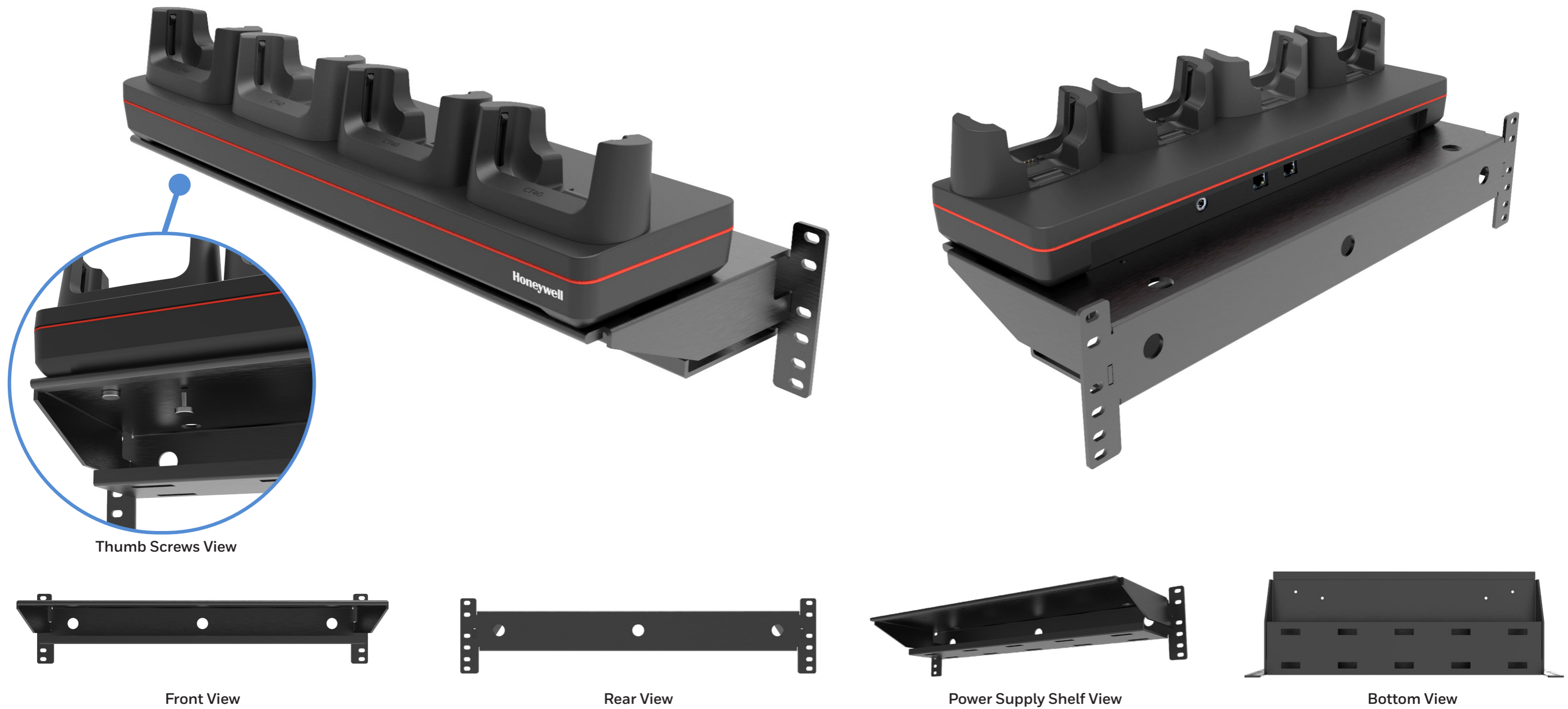

	PART NUMBER	DESCRIPTION
1	CB-BK-01	4 Bay Charger Bracket, Rack / Wall Mount (includes 4 x 50180100-001 Thumb Screws M3.5x10 to securely attach the 4-bay dock to the bracket)

CK62 BATTERY

Spare Battery Options



Standard CK62
CK62-xxx-xxxxxxx

PART NUMBER	DESCRIPTION
1 CK67-BTSC-001	Smart Battery Pack, CK67/CK62 (7000mAh)

MISCELLANEOUS

Optional Parts



PART NUMBER	DESCRIPTION
CK62-HS-5PK	CK62 Hand Strap (5 pieces per pack)



PART NUMBER	DESCRIPTION
EDA61K-SHS-3PK	Hand Strap for CK62/EDA61K Scan Handle (3 pieces per pack)

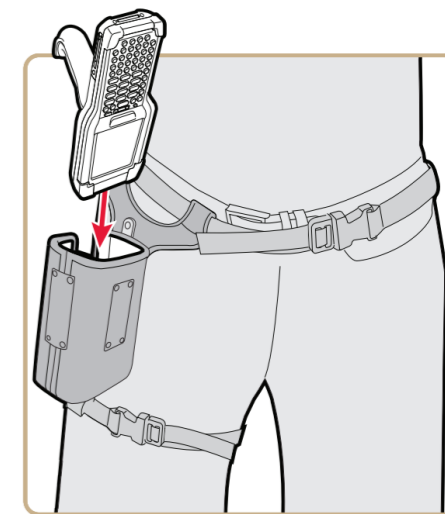

PART NUMBER	DESCRIPTION
815-088-001	Holster, CK3R/CK3X/CK62/CK65/CK67 with Scan Handle (Holster w/ Belt, supports CK3R/CK3X/CK62/CK65/CK67 with scan handle)

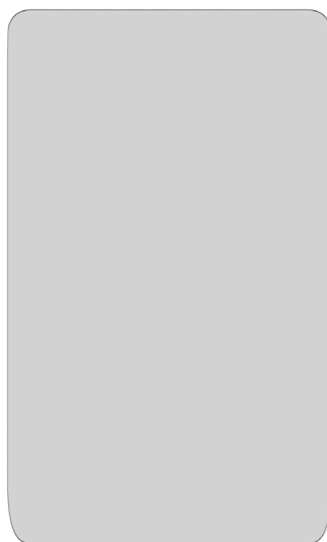

PART NUMBER	DESCRIPTION
CK62-SP-10PK	CK62 Screen Protectors, Pack of 10



PART NUMBER	DESCRIPTION
50136024-001	KIT, 5V/2A Power supply, Scanpal EDA 50k / 51 / 60 / 61K / 70 / 71/52/5S. Mobility Edge CT40 / CT60 . Includes 5 PLUGS PACKED US,UK,AU,EU,IN adapters.

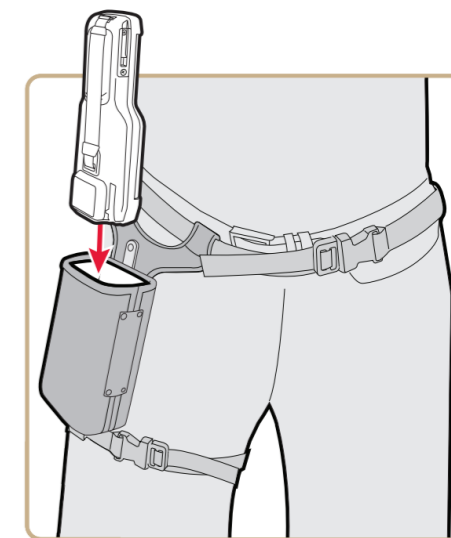

PART NUMBER	DESCRIPTION
815-087-001	Holster, CK3R/CK3X/CK62/CK65/CK67 without Scan Handle

MISCELLANEOUS

Optional Parts

Replacement Power Supplies.



IEC C14



IEC C14



IEC C6

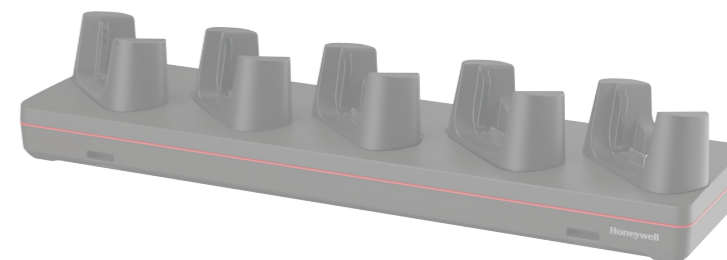

PART NUMBER DESCRIPTION

50121666-001 Power Adapter, 12V 3A, No Power Cord, Homebase / eHomebase / Quad Battery Charger (Requires IEC C13 AC Power Cord)

PART NUMBER DESCRIPTION

CK6X-BC-PWRSUPPLY Power Adapter, 12V 15A, No Power Cord 16 Bay Battery Charger (Requires IEC C13 AC Power Cord)

PART NUMBER DESCRIPTION

50121667-001 Power Adapter, 12V 7A, No Power Cord, CT40 Quad Chargebase/Quad Netbase (Requires IEC C13 AC Power Cord)

PART NUMBER DESCRIPTION

3007-3408-001 Power Supply 12V 8.3A R7B ADS-120QL-12-3 120100E 5-Bay Charge Base (Requires IEC C5 AC Power Cord)

MISCELLANEOUS

Optional Parts

Replacement Universal Cups.

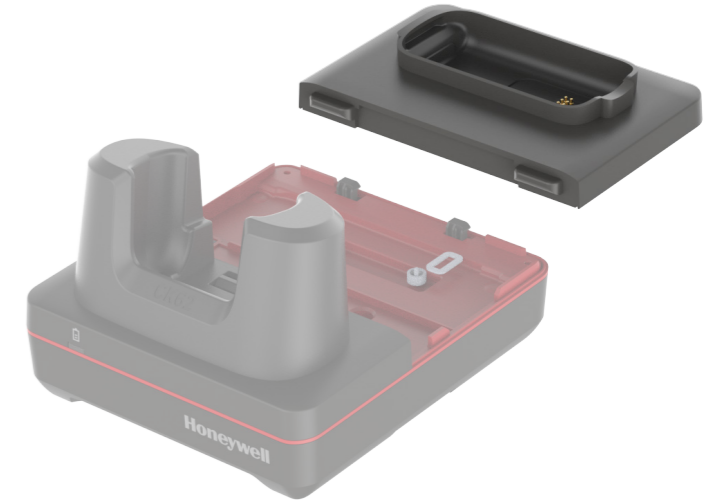

PART NUMBER	DESCRIPTION
CK62-UCP-N	CK62 Universal Cup

PART NUMBER	DESCRIPTION
CK6X-UCP-BATTHEB	CK67 Home Base and Ethernet Base battery cup. Cannot charge a mobile computer.



PART NUMBER	DESCRIPTION
CK6X-UCBC-4B	CK67 Battery Universal Cup. Kit includes a cup to be used for up to 4 pieces CK67 batteries

MISCELLANEOUS

Micro-SD Cards

Honeywell Recommended – ATP Industrial Grade Micro SD Cards

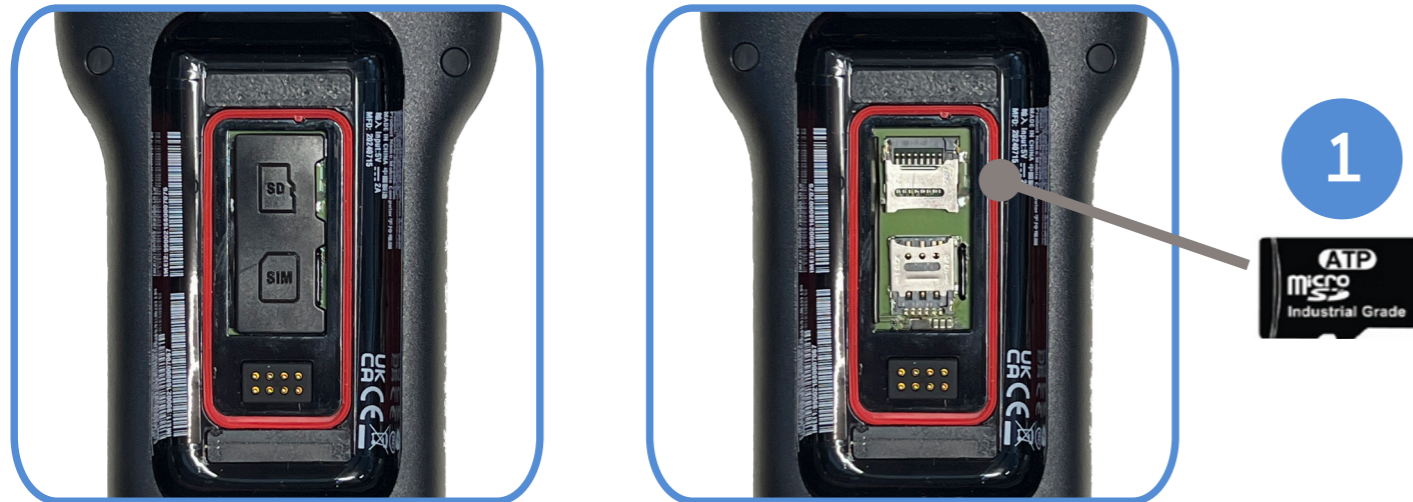

Why ATP Industrial Grade SD?

ATP's SIP (System-In-Packaging) manufacturing process encapsulates all exposed components and points of failure to ensure the products are fully waterproof, shockproof, and ESD (Electro-Static Discharge) proof. ATP Industrial Grade SD/SDHC Cards can withstand at least an operating/storage temperature range of at least -40 to 85 degrees Celsius. In addition to this temperature range, the cards are completely waterproof, dustproof, and ESD (Electro-Static Discharge) proof. All ATP Industrial Grade SD/SDHC cards are produced under a stringent RoHS and Green Package compliant manufacturing process to guarantee a consistent high level of build quality and performance. ATP Industrial SD cards deliver outstanding performance with read speed (seq) up to 18MB/sec and write speed (seq) up to 16MB/sec. All ATP Industrial Grade CF, SD, USB drives, and SSDs are constructed using best-in-class SLC(Single-Level Cell) components with enhanced Error Correction Code(ECC) functions and wear levelling algorithms. This results in MTBF ratings over 2 million hours and the highest write cycle lifetimes in the industry.

	PART NUMBER	DESCRIPTION
1	856-065-004	MICRO-SD CARD, 1GB , AFIGUDI, ROHS
OR	856-065-005	MICRO-SD CARD, 2GB , AFIGUDI, ROHS
OR	856-065-006	MICRO-SD CARD, 4GB , AFIGUDI, ROHS
OR	856-065-007	MICRO-SD CARD, 8GB , AFIGUDI, ROHS

AC Cords

Regional Power Cords



AC Power - C13 Type Connector

PART NUMBER	TYPE	DESCRIPTION
50117501-001	C13	POWER CORD AUSTRALIA 2500MM,SLED CB
321-501-002	C13	AC Power Cord, Denmark RoHS
77900508E	C13	Cable: power cord, straight, Power cord, Europe EU, IEC320-C13, 2.5 m (8.2 ft)
321-502-002	C13	AC Power Cord, India/South Africa RoHS
321-500-002	C13	AC Power Cord, Japan RoHS
9000093CABLE	C13	AC POWER CABLE, C14 TYPE, SWITZERLAND 3-PIN
77900507E	C13	Cable: power cord, straight - Power cord, UK, IEC320-C13, 2.5 m (8.2 ft)
130063	C13	AC Power Cord, US RoHS









AC Power - C5 Type Connector

PART NUMBER	TYPE	DESCRIPTION
3007-4681-001	C5	C5 type power cable, USA
3007-4683-001	C5	C5 type power cable, Europe
3007-4682-001	C5	C5 type power cable, UK
3007-4684-001	C5	C5 type power cable, Australia

APPENDIX

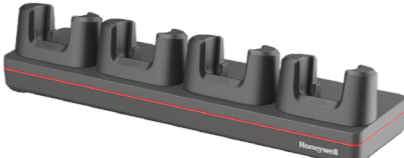







CK62 vs EDA61K Chargers

ACCESSORIES							
Category	Description		 CK62	 EDA61K	Is the CK62 part the same as EDA61K?	Is the CK62 part compatible with EDA61K?	Notes
Home Base	Universal Dock Home Base	 CK62-HB-UVN-0	Supported	Supported	No	Yes	
	Home Base	 EDA61K-HB-0	Supported	Supported	Yes	Yes	
Charge Base	Universal Dock Charge Base	 CK62-CB-UVN-0	Supported	Supported	No	Yes	
	Charge Base	 EDA61K-CB-0	Supported	Supported	Yes	Yes	
	5-Bay Charge Base with Battery Cup	 CK62-5CB-UVN-BAT-0	Supported	Supported	No	Yes	

APPENDIX

CK62 vs EDA61K Battery Chargers

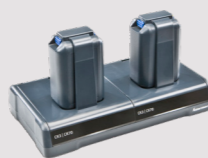
ACCESSORIES

Category	Description	Supported Batteries	 CK62	 EDA61k	Notes	
Batteries	CK62 Battery	 CK67-BTSC-001	Supported	Supported	CK62 battery is compatible with EDA61k	
	EDA61k Battery	 50149348-001	Not Supported	Supported	EDA61k battery is NOT compatible with CK62.	
Battery Charger	Universal Dock 4-Bay Battery	 CK6X-BC-4BAY-0	CK67-BTSC-001 - Smart Battery Pack,CK67/CK62 (7000mAh)	Supported	Supported	
			50149348-001 - Battery Pack, EDA61K (7000mAh)	Supported	Supported	
	Legacy CK3 Quad Battery	 871-230-101 (ROW) 871-230-301 (USA)	CK67-BTSC-001 - Smart Battery Pack,CK67/CK62 (7000mAh)	Supported	Supported	
			50149348-001 - Battery Pack, EDA61K (7000mAh)	Supported	Supported	
	FlexDock 4-Position Battery	 DX2A22220 (ROW) DX2A22210 (USA)	CK67-BTSC-001 - Smart Battery Pack,CK67/CK62 (7000mAh)	Supported	Supported	
			50149348-001 - Battery Pack, EDA61K (7000mAh)	Supported	Supported	
	FlexDock 8-Position Battery	 DX4A2BBBB00 (ROW) DX4A2BBBB10 (USA)	CK67-BTSC-001 - Smart Battery Pack,CK67/CK62 (7000mAh)	Supported	Supported	
			50149348-001 - Battery Pack, EDA61K (7000mAh)	Supported	Supported	
	Universal Dock 16-Bay Battery	 CK6X-BC-16BAY-0	CK67-BTSC-001 - Smart Battery Pack,CK67/CK62 (7000mAh)	Supported	Supported	
			50149348-001 - Battery Pack, EDA61K (7000mAh)	Supported	Supported	

MISCELLANEOUS

Disclaimer

Honeywell International Inc. (“HII”) reserves the right to make changes in specification and other information contained in this document without prior notice, and the reader should in all cases consult HII to determine whether any such changes have been made. The information in this publication does not represent a commitment on the part of HII.

HII shall not be liable for technical or editorial errors or omissions contained herein; nor for incidental or consequential damages resulting the furnishing, performance, or use of this material.

This document contains proprietary information that is protected by copyright. All rights are reserved. No part of this document may be photocopied, reproduced, or translated into another language with-out prior written consent of HII.

Web Address: automation.honeywell.com

The Bluetooth trademarks are owned by Bluetooth SIG, Inc., U.S.A and licensed to Honeywell.

Thor and Mobility Edge are trademarks or registered trademarks of Honeywell International Inc. in the United States and/or other countries.

Android is a trademark or registered trademark of Google Inc. in the United States and/or other countries. Windows is a trademark or registered trademark of Microsoft Corporation.

Qualcomm and Snapdragon are trademarks or registered trademarks of Qualcomm Incorporated in the United States and/or other countries.

Other product names mentioned in the manual may be trademarks of registered trademarks of their respective companies and are the property of their respective owners.

All rights reserved.

For more information

automation.honeywell.com

Honeywell Safety and Productivity Solutions

300 S Tryon St Suite 500

Charlotte, NC 28202

800-582-4263

www.honeywell.com